

Accessori

Connettori

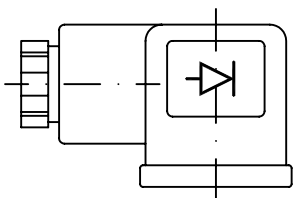

Raddrizzatori

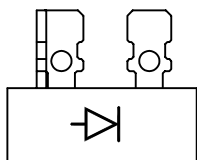

Molle compensatrici

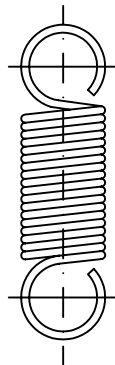

Molle di ritorno

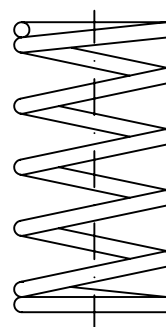

Raccordi M.F.

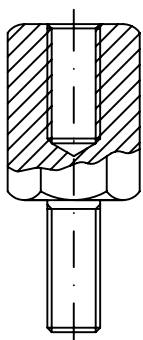

Morsetti serrafilo

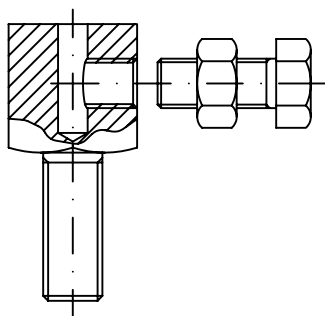

Boccole ferma guaina

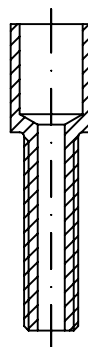

Raccordi F.F.

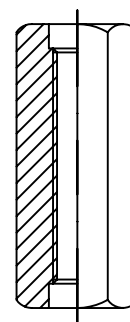

Raccordi M.M.

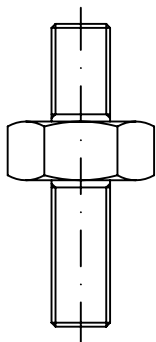

Snodi sferici assiali

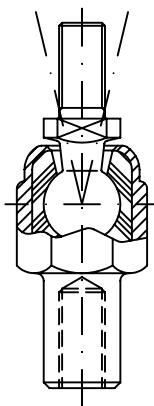

Snodi sferici 90°

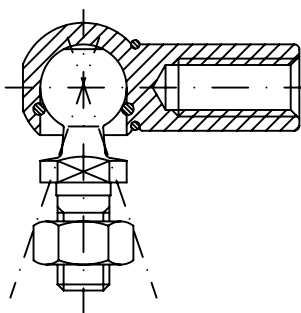

Gommini parapolvere

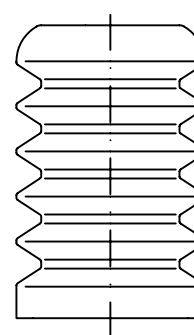

Tiranti a forcilla

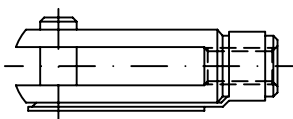

Compensatori di corsa

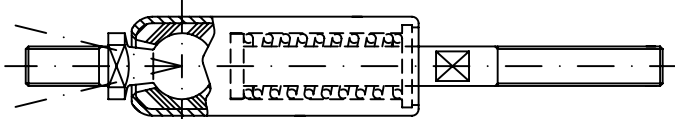

Cavi con guaina

